

# A Accessories

## Common Accessories

### ■ Contact Blocks and LED Blocks for Ø16 Control Switches

#### ○ Ordering Information



SA	16	CB	W		
Item	Applied switches	Type	LED color <sup>※1</sup>	<b>LED block</b>	<b>R</b> Red
				<b>B</b> Blue	
				<b>G</b> Green	
				<b>Y</b> Yellow	
				<b>W</b> White	
	<b>CB</b> <sup>※2</sup>	Contact block	<b>B</b> B contact (normally closed)		
			<b>C</b> C contact (normally open, normally closed)		
		<b>L5</b>	LED block	5VDC	
	<b>L12</b>		12VDC		
	<b>L24</b>		24VDC		
<b>16</b>	For Ø16 control switches				
<b>SA</b>	Switch Accessories				

※1. Only for LED blocks.

※2. Only for Ø16 emergency switches.

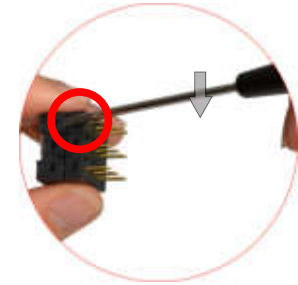
- **Contact block and LED block removal**  
Separate the unit using a flat-head (-) screwdriver.



Item	Appearance	Model	Type	Features
Contact block		SA16-CB	B contact (normally closed)	For Ø16 emergency switches
		SA16-CC	C contact (normally open, normally closed)	—
LED block		SA16-L5□ (5VDC) SA16-L12□ (12VDC) SA16-L24□ (24VDC)	DC voltage type	Diverse, vibrant, high luminance LEDs (red, blue, green, yellow, white)

**■ Contact Blocks and LED Blocks for Ø22/25, Ø30, □30 Control Switches**

**○ Ordering Information**

<b>SA</b>	<b>CA</b>	<b>M</b>	
Contact block type	<b>No-mark</b>	Singular type	
	<b>M</b>	Modular type	
LED color <sup>※1</sup>	<b>No-mark</b>	White	
	<b>R</b>	Red	
	<b>B</b>	Blue	
	<b>G</b>	Green	
	<b>Y</b>	Yellow	
Type	<b>CA</b>	Contact block	A contact (normally open)
	<b>CB</b>	Contact block	B contact (normally closed)
	<b>LD</b>	LED block	AC/DC voltage: 12-24VAC 50/60Hz 12-24VDC
	<b>LA</b>		AC voltage: 110-240VAC 50/60Hz
Applied switches	<b>No-mark</b>	For Ø22/25, Ø30, □30 control switches	
	<b>SA</b>	Switch Accessories	
Item			

• **Contact block and LED block removal**  
Separate the unit using a flat-head (-) screwdriver.



※1. Only for LED blocks.  
※Multi-unit connection is only available for modular type (SA-□M).

Item	Appearance	Model	Type	Features
Modular type contact block		SA-CAM	A contact (normally open)	Ring or spade terminals / Multi-connection (up to 3 units)
		SA-CBM	B contact (normally closed)	
Singular type contact block		SA-CA	A contact (normally open)	Spade terminals only / Loose screw prevention
		SA-CB	B contact (normally closed)	
Modular type LED block		SA-LD□M	AC/DC voltage type 12-24VAC 50/60Hz 12-24VDC	Diverse, vibrant, high luminance LEDs (Red, Blue, Green, Yellow, White)
		SA-LA□M	AC voltage type 110-220VAC 50/60Hz	
Singular type LED block		SA-LD□	AC/DC voltage type 12-24VAC 50/60Hz 12-24VDC	
		SA-LA□	AC voltage type 110-220VAC 50/60Hz	

**Control Switches**

- Ø16
- Ø22/25
- Ø30
- 30

**Push Button Switches**

- Round
- Square
- Rectangular

**Selector Switches**

- Round
- Square
- Rectangular

**Key Selector Switches**

- Round
- Square
- Rectangular

**Double Push Button Switches**

**Mushroom-head Push Button Switches**

**Emergency Switches**

**Pilot Lights**

**Accessories**

**Buzzers**

# A Accessories

## Switch Enclosures for Ø22/25 Control Switches

### Ordering Information

SA		SB	3	
Item	Applied switches	Appearance	Holes	
			1	1 hole
			2	2 holes
			3	3 holes
			4	4 holes
Item	Applied switches	Appearance	SB	Square type
			TB	Triangle type
			No-mark	For Ø22/25 control switches
Item			SA	Switch accessories



※You can order the other size and the number of holes.

• Hole size: Ø22.5/25.5mm

(unit: mm)

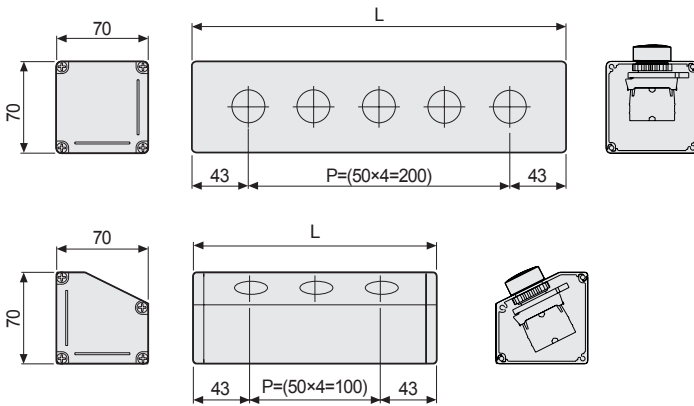

Holes	L
1	86mm
2	136mm
3	186mm
4	236mm
5	286mm













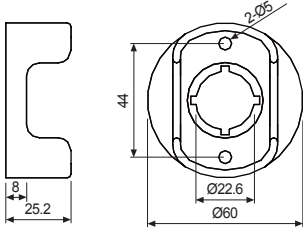

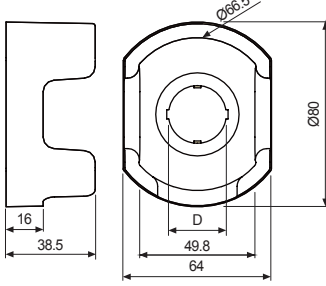
## Locking Handle for Switches

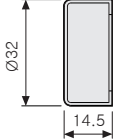
Applied switches	Appearance	Model	Note
Ø16		SA16-LH	For locking switch nuts behind the panels
Ø22/25, Ø30 <sup>※1</sup> , □30		SA-LH	

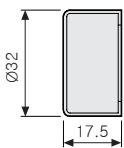
※1. Except Ø30 round pressure switches (extended).

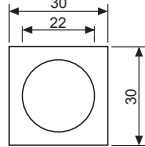
## Accessories By Item

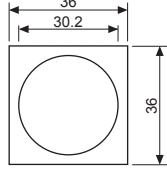
(unit: mm)

Item	Appearance	Model	Dimensions	Note						
Emergency switch nameplates		SA-NS	Size: D60×d25	Standard and illuminated nameplates are available for emergency switches. ※Illuminated nameplates are optional. ※D60 emergency switches (S2ER-E5R□) are not compatible with SA-NS nameplates						
		SA-NL	Size: D80×d25							
Protective shrouds for emergency switches		SA-EG1		Protective shrouds to prevent accidental/incorrect operation <table border="1" style="margin-top: 10px;"><thead><tr><th colspan="2">D</th></tr></thead><tbody><tr><td>SA-EG2</td><td>Ø22.5</td></tr><tr><td>SA-EG3</td><td>Ø25.5</td></tr></tbody></table> ※Not available for D60 emergency switches (S2ER-E5R□).	D		SA-EG2	Ø22.5	SA-EG3	Ø25.5
	D									
SA-EG2	Ø22.5									
SA-EG3	Ø25.5									
	SA-EG2/ SA-EG3									
Waterproof cap for Ø22/25 round push button switches		SA-WP (non-illuminated/ extended)		IP65 protection structure with waterproof cap						
	 (extended)	SA-WL (illuminated/ extended)								
Ø20/25 Switch washer		SA-SW2		The washer helps to improve switch tightening force.						
Ø30 Switch washer		SA-SW3								
Lens remover for Ø16 push button control switches or pilot lights		SA16-RM		Lens remover for push button control switches or pilot lights						

Control Switches

Ø16

Ø22/25

Ø30

□30

Push Button Switches

Round

Square

Rectangular

Selector Switches

Round

Square

Rectangular

Key Selector Switches

Round

Square

Rectangular

Double Push Button Switches

Mushroom-head Push Button Switches

Emergency Switches

Pilot Lights

Accessories

B buzzers